

NEWS FOR THE ELECTRONICS INDUSTRY

element14

AN AVNET COMPANY

# eTECH JOURNAL

ISSUE 3

INDUSTRIAL  
AUTOMATION  
ALL THE  
POWER &  
CONTROL

LEVERAGE  
THE INTERNET  
OF THINGS TO  
SET UP A  
SMART  
FACTORY

+

MOTOR  
CONTROL  
SOLUTIONS

IO-LINK® SMART  
INDUSTRIAL  
AUTOMATION

AGILE  
DEVELOPMENT  
LIFECYCLE FOR  
AUTOMATION

POWERING  
AUTOMATION

# INDUSTRIAL EMBEDDED COMPUTERS

## Enabling Next Generation of Industrial Applications

We offers the latest cutting-edge industrial embedded computers designed for use in today's most demanding industrial IoT and edge computing environments.

To give you peace of mind, our industrial computers help reduce downtime and prevent failures. Embedded computers from industry-leading suppliers are available in a variety of form factors that are ideal for space-constrained implementations and are engineered for performance and reliability.

[LEARN MORE](#)



Rugged for harsh environments



Multiple connectivity



Compact form factors



Compliance and support



Long time availability



Extended I/Os

intel

Industrial Shields

KUNBUS  
Industrial communication

NXP

Raspberry Pi

XILINX



## CONTENTS

- 04 FAST AND HIGH PRECISION MOTOR CONTROL FOR HIGH PERFORMANCE
- 08 IO-LINK®, A PIVOTAL TECHNOLOGY FOR SMART INDUSTRIAL AUTOMATION
- 16 AUTOMATE AWAY COMPLEXITY & REPETITIVENESS WITH ROBOTIC PROCESS AUTOMATION



## 20 LEVERAGE THE INTERNET OF THINGS TO SET UP A SMART FACTORY

## 32 AUTOMATION POWER MODULES: TYPICAL FAILURE MODES AND HOW TO SOLVE THEM



To register for all future editions and to access all back issues of eTech Journal, scan QR code

Editor-in-chief: Cliff Ortmeier, Managing Editor: Ankur Tomar

©Premier Farnell. All rights reserved. No portion of this publication, whether in whole or in part, can be reproduced without the express written consent of Premier Farnell. All other registered and/or unregistered trademarks displayed in this publication constitute the intellectual property of their respective holders. Errors and omissions in the printing of this magazine shall not be the responsibility of Premier Farnell. Premier Farnell reserves the right to make such corrections as may be necessary to the prices contained herein.

## WELCOME

The traditional manufacturing industry is undergoing a digital transformation that is being accelerated by exponentially growing technologies all over the world (e.g. intelligent robots, autonomous drones, smart sensors, 3D printing). Understanding, developing and implementing integrated strategies that leverage Industry 4.0 technologies is already a priority for many organisations in this rapidly changing world.

Naturally, there is a strong correlation between having Industry 4.0 woven throughout one's strategy and believing that IoT, AI, cloud, and big data/analytics will have a significant impact on the organisation. The electronics industry is already responding with smaller and smarter sensors, more reliable connectors, more adaptable enclosure systems and faster and more convenient wired and wireless communications technologies. IIoT is providing a digital backbone for the emergence of Industry 4.0, the broader set of operating principles that are set to deliver the smarter factories of the future, by combining sensor data, machine communications, and automation systems. The challenge now is to identify the intermediate steps necessary to harness and realise the benefits of an Industry 4.0 future. Companies and their industrial processes must adapt to this rapid change if they are not to fall behind developments in their industry and competitors.

In this issue, eTechJournal discusses how to leverage industrial IoT to set up a smart factory for manufacturing, as well as how to use robotics to automate complexity and repetitiveness. We also look at fast and precise motor control for high-performance industrial applications, as well as how IO-Link is becoming pivotal technology for smart industrial automation - changing the way manufacturers design and build their products.

We hope you enjoy this edition and welcome your comments and suggestions. Please feel free to drop us a note.



Cliff Ortmeier Editor, eTech Journal  
Email: [editor-TJ@element14.com](mailto:editor-TJ@element14.com)



# FAST AND HIGH PRECISION MOTOR CONTROL FOR HIGH PERFORMANCE

## MOTOR CONTROL OVERVIEW

Electric motor control is a key functionality of machines installed in industrial manufacturing sites.

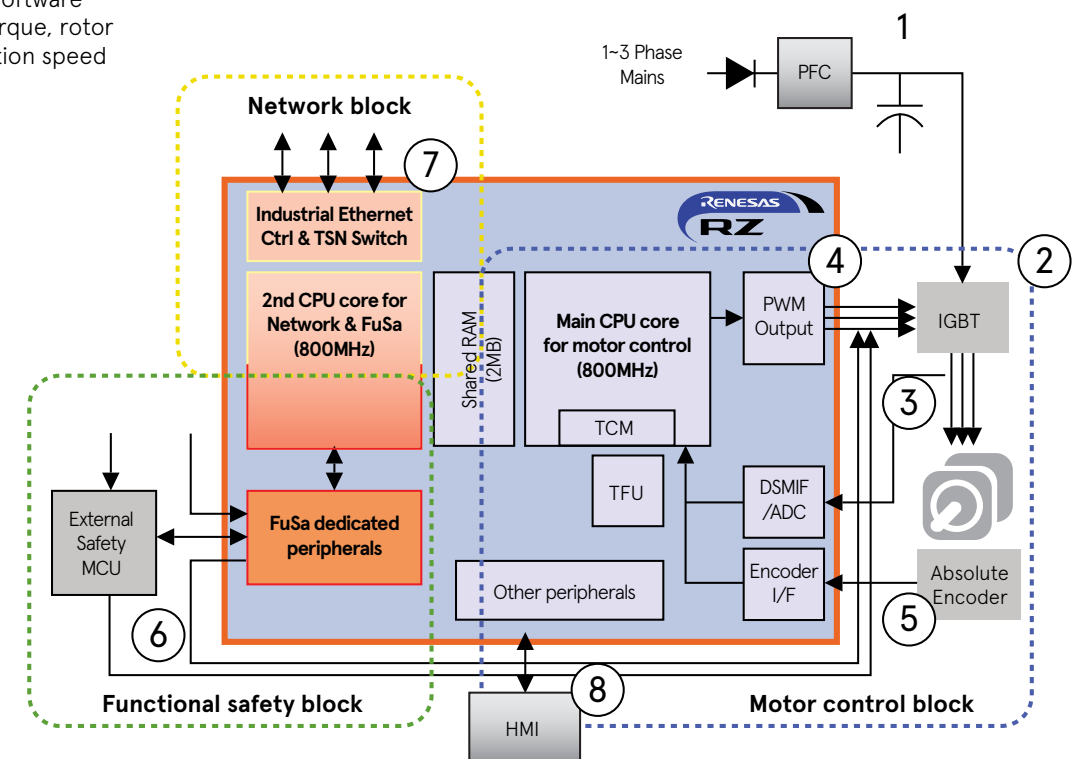
Typically, these motors operate synchronously or asynchronously with a three-phase current supplied by the driver unit. This driver unit comes in many types and its capabilities can be as simple as rotating a motor at a certain revolution speed; or as complex as simultaneously controlling of the multiple axis of a robot arm or other complex machinery to enable fast and precise movements along three-dimensional trajectories. They can have additional features like controlling local user interfaces, communicating via industrial buses or Ethernet, predictive maintenance, or functional safety and security against counterfeiting or cyber-attacks. Looking at all these requirements and keeping cost, power consumption and heat dissipation in mind, it becomes obvious that there is no "one size fits all" solution. For the simplest motor drive applications, a standard 16bit MCU can be fully sufficient. But when it comes to high-end applications, typically a superset of the mentioned motor driver functions is required. This becomes a significant cost factor in terms of BOM list, development and certification efforts.

## FUNCTIONAL BLOCKS

A motor driver unit as shown in Figure 1 typically consists of these parts:

- 1 Power input and storage**  
The single- or three-phase AC mains power is rectified and charges an integrated high voltage capacitor. Optionally, this stage offers additional features like power factor correction (PFC)
- 2 Three-phase full bridge**  
This bridge switches the DC voltage individually to the three terminals of the motor. It generates sinusoidal waves by alternating the respective positive or negative outputs.
- 3 Motor current sensing**  
The current feedback informs the bridge controller about the operation state of the motor. The motor control software determines load/torque, rotor position and revolution speed from these data.
- 4 Bridge control**  
A high frequency, high precision PWM of the bridge controller shapes the motor currents. The motor control algorithms executed on the CPU determine the pulse setup of each motor phase for each new output period. The higher the CPU performance, the more accurate and energy efficient the motor movements.
- 5 Position feedback (optional)**  
For servo systems, the precise feedback of positions linked to the motor drive is a crucial part of the control loop. Position feedback can be obtained in various ways and interface formats.
- 6 Functional safety monitoring and shut-off (optional)**  
Functional safety can be as simple as safe torque off (STO) triggered by the operator of a machine pressing a safe-stop button. In more advanced use cases, the safety system must monitor movements of machines or robots to enable interactive working with humans in production processes or support maintenance and repair by technicians.
- 7 Industrial bus or Ethernet support (optional)**  
For remote control of the drive, industrial field buses or industrial Ethernet communication is applied. The control methods range from simple status monitoring and parameter setting through to closed control loops for precise and fast motion control.
- 8 User interface (optional)**  
In particular low-end drives without remote control capabilities provide user interfaces to set drives parameters or allow simple actions like start-stop or RPM control of the motor.

Figure 1: Typical setup of a motor driver unit



## SOLUTIONS

For high-end servo applications, which need to cover a rich feature set, the BOM list tends to be long and costly. The most effective way to counter this is by integrating all required functions into a single chip solution like the new Renesas RZ/T2M servo motor control device. Beyond a significantly shorter BOM list, this integrated solution comes with many more advantages:

- Scalable hardware platform allowing application software reuse
- Powerful Cortex R52 ARM CPU core with Tightly Coupled Memory (TCM) supporting hard real-time processing

- Trigonometric Function Unit (TFU) to accelerate complex mathematical algorithms
- Matured, feature-rich set of peripheral IP for PWM generation, Delta-Sigma I/F, SAR-ADC, digital encoder I/F etc.
- 3-port multi-protocol Ethernet network including Time Sensitive Networking (TSN) support
- Software ecosystem consisting of matured peripheral drivers, software stacks and application samples
- Pre-certified functional safety platform software
- Pre-certified industrial network stacks
- Embedded security for anti-counterfeiting and secure network communication
- Configurable absolute encoder interfaces for future prove encoder support
- Sample applications and demo boards to start evaluating out of the box
- Long term availability as part of the PLP program

The more extensive the feature set of the silicon device, the more likely it can cover today's and future requirements.

For efficient developments with low schedule risk, the completeness of the development environment is crucial. The Renesas RZ/T2M device comes with a rich set of tools and software solutions (see Fig. 2), helping application developers in all aspects of his project.



Figure 2: Development environment

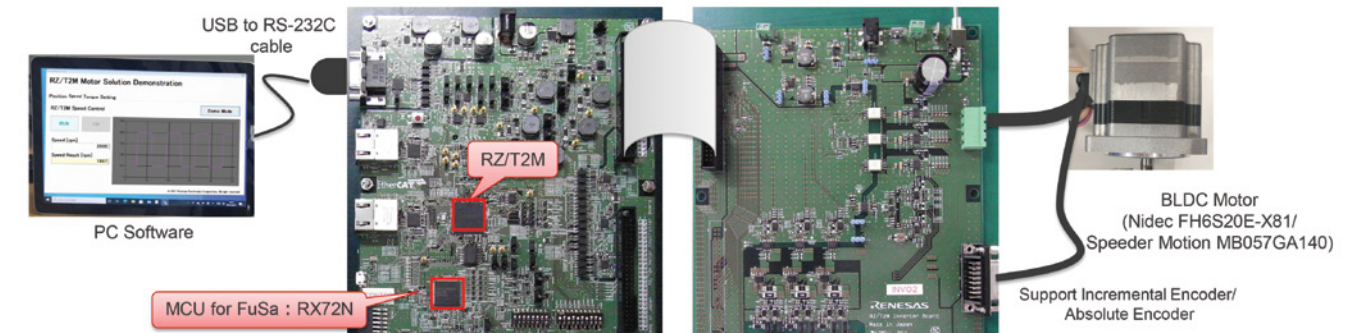
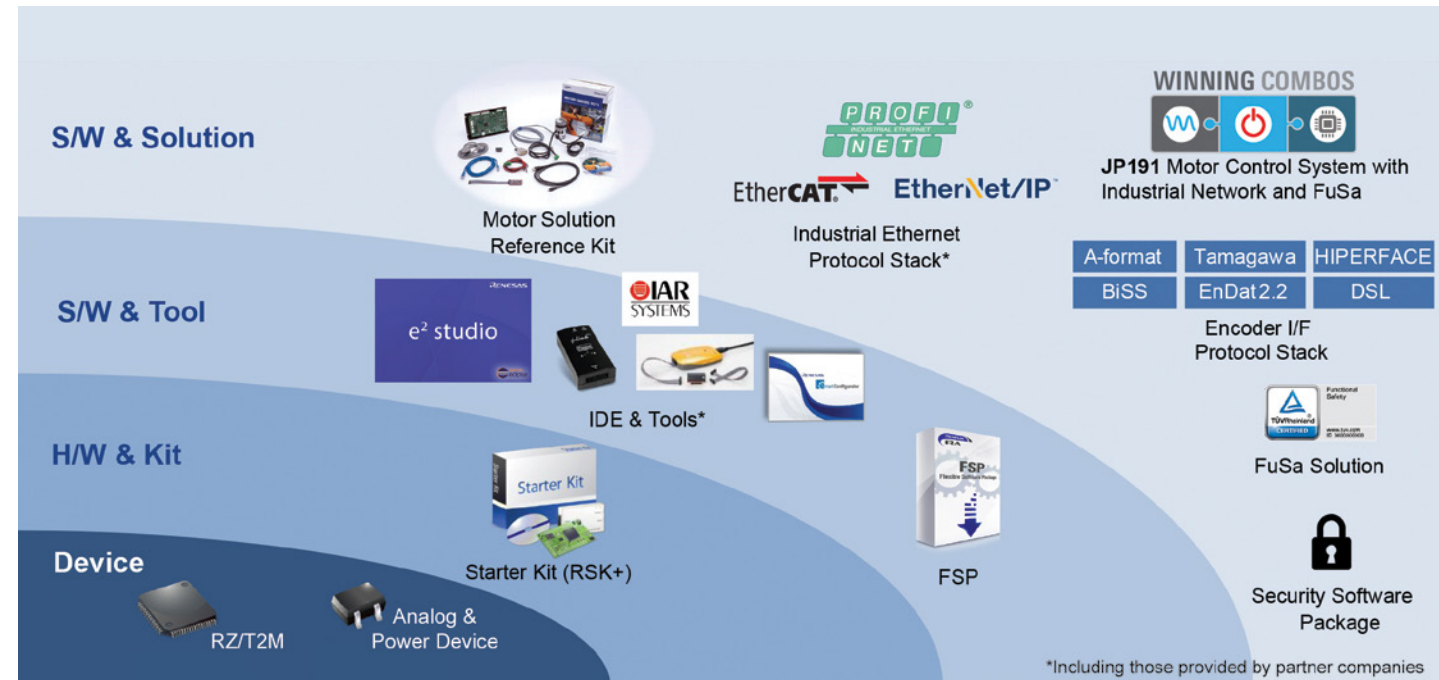


Figure 3: Servo motor control reference application with functional safety

As every solution has its pros and cons, a thorough evaluation of different offers is the key for successful and sustainable product developments with minimized risk. Availability of hardware and software as sample applications is essential to swiftly compare different solutions, confirm their suitability, and feature coverage.

As implementation concepts and detailed feature sets differ, there is no single reference for a complex application like a servo drive. However, a feature rich sample application (see Figure 3) can provide coverage of today's and future requirements and, when used as a template for companies' own developments, minimizing their risk and schedule.

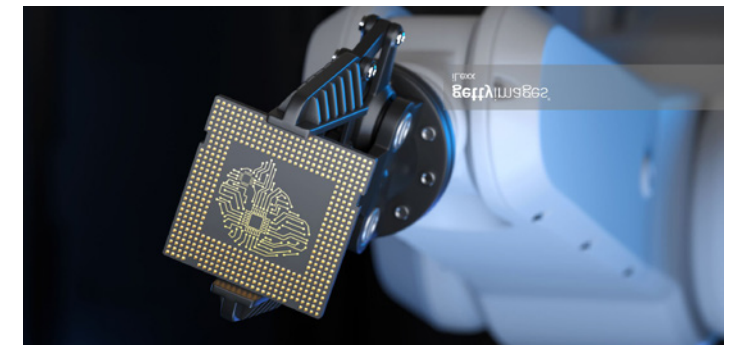
### FURTHER READING

To learn more about Renesas Motor Control System with Industrial Network and Functional Safety Solutions,

[CLICK HERE](#)

# IO-LINK®, A PIVOTAL TECHNOLOGY FOR SMART INDUSTRIAL AUTOMATION

Historically, an industrial sensor included a sensing element and a way to transfer sensing data to a controller. Data was often transferred in analog format and was unidirectional (sensor to host/controller only). Unfortunately, this approach often added extra steps (e.g. digital-to-analog and analog-to-digital conversion) to the overall sensor functionality which, in turn, added extra cost, larger footprints and susceptibility to noise.



These “old school” sensors did work (and do continue to work today!), and as technology advanced, sensor manufacturers were able to integrate more functionality into sensors that eliminated some of these problems. Data, however, was still restricted to unidirectional communication from the sensor to the controller, limiting error control and often requiring manual calibration or updates. Manufacturers needed a better solution to meet the increasing demands for smart automated sensors and the solution that emerged was IO-Link.

Analog Devices (ADI) provides a portfolio of advanced industrial automation solutions that create pathways toward achieving Industry 4.0, enhanced by its IO-Link technology portfolio.

IO-Link is a standardized technology (IEC 61131-9) regulating how sensors and actuators in industrial systems interact with a controller, allowing bidirectional communication and configuration between a sensor and a controller. IO-Link functionality in a system reduces maintenance, increases uptime, and transforms a manual sensor installation into one which allows a user to “plug-and-play and walk away.”

This type of communication between an IO-Link master and an IO-Link device allows for continuous diagnostics and improved data logging and error detection to further reduce operating costs. Commonly used connectors (for example M8 and M12) and cables, as explained in the IEC 61131-9, enable standardized installation with direct binary sensor upgrades.

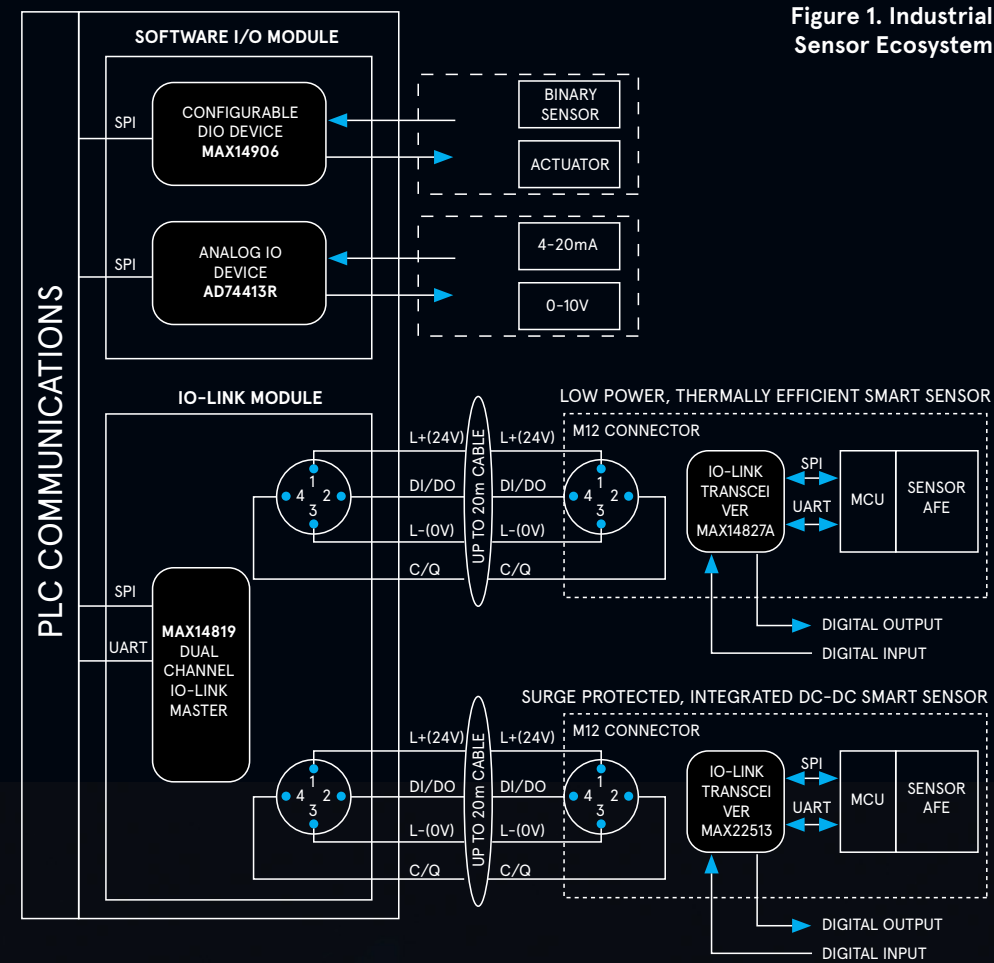


Figure 1. Industrial Sensor Ecosystem

IO-Link is very powerful and flexible, allowing some of the overall system intelligence to be moved closer to the sensors on the factory floor. An IO-Link master is coupled with a device using a standard sensor/actuator cable measuring up to 20 meters in length. The device - which may be any sensor, any actuator, or a combination of the two - transmits and receives data (binary switching, analog, input, output) that is transmitted directly via IO-Link in a digital format. Figure 1 shows a typical industrial sensor ecosystem including analog I/O, digital I/O, and IO-Link connection.

As shown in Figure 1, IO-Link transceivers that include an additional digital output (DO) and/or digital input (DI) allow the device microcontroller to process binary signals in addition to IO-Link communication. For example, the additional DI and DO connections can allow the on-board microcontroller to also input signals from a binary sensor, and drive a lamp (e.g. if a threshold has been surpassed). In short, all processing can be done at the sensor itself.

Since IO-Link and binary sensors can have configurable settings (for example PNP, NPN, or push-pull outputs that can be changed while in progress), the number of product units the sensor vendor needs to support is also reduced. IO-Link communication allows parameter settings to be downloaded from the controller to set up, or reconfigure, a device. This means a technician is no longer needed to do initial setup and machine downtime is reduced when it is required to reconfigure devices.

## IO-LINK SYSTEM



IO-Link is a standard for Single-Drop Communication Interface (SDCI) while also providing backwards-compatibility with binary sensors IEC 60974-5-2.

The connection between the IO-Link master (multi-port controller or gateway) and the IO-Link device (sensor or actuator) uses standard connectors and a 3- or 4-wire cable up to 20 meters in length.

The master can have multiple ports (commonly four or eight). Each port connects to a unique IO-Link device, which can operate in either SIO mode or bidirectional communication mode. IO-Link masters can interface with both binary and IO-Link sensors, allowing IO-Link to be easily added to an existing system. IO-Link is designed to work with existing industrial architectures such as fieldbus or industrial Ethernet and connects to existing PLCs or human-machine interfaces (HMIs), enabling rapid adoption of this technology.

IO-Link communication is point-to-point between an IO-Link master and a device using a 3-wire interface (L+, C/Q, and L-). The supply range in an IO-Link system is 20V to 30V for the master, and 18V to 30V for the device.

The two communication modes between an IO-Link master and a device are standard I/O (SIO) and SDCI (IO-Link). In SIO mode, backward compatibility is ensured with existing sensors in the field, using 0V or 24V to signal OFF or ON to the IO-Link master. In IO-Link mode, communication is bidirectional at one of the three allowed data rates: COM1 (4800 baud), COM2 (38.4kbau), and COM3 (230kbau). The IO-Link device only supports one data rate while the IO-Link master must support all three data rates. Communication typically uses 24V pulses using a nonreturn-to-zero (NRZ) on the C/Q line where a logic 0 is 24V between C/Q and L- and a logic 1 is 0V between C/Q and L-. In IO-Link mode, pin 2 can be in DI mode as a digital input, or DO mode as a digital output, or not connected (NC).

## IO-LINK SENSOR DESIGN CONSIDERATIONS

The basic structure of an IO-Link sensor includes some fundamental building blocks (Figure 2) which the system designer must consider. These building blocks include the sensor type (optical, temperature, etc.), the microcontroller that interfaces with the sensor and runs the IO-Link device software stack, the IO-Link transceiver (or physical layer/PHY), the power supply and the various voltage and current ratings required, the connector type, and any external protection required (e.g. TVS for surge, EFT/burst, ESD, etc.)

Analog Devices' long and committed history with IO-Link technology has resulted in the development of multiple generations of transceivers, on both the IO-Link master and device side, that focus on low power dissipation, small solution size, and robust communications.

ADI has a proven track record of long-term dedication and commitment to the industrial market, and to its customers, by having the industry's most complete IO-Link and binary sensor portfolios.

These include the MAX14828, MAX14827A, MAX22513, MAX22514, and MAX22515 device transceivers.

The MAX14828 single-channel transceiver, and the MAX14827A dual-channel transceiver, dissipate a remarkably low 70mW when driving a 100mA load - achieving more than 80% lower power dissipation than the closest competitive device. The MAX22513 and MAX22514, the latest generation IO-Link transceivers in the ADI portfolio, feature an internal high-efficiency DC-DC buck regulator, low on-resistance drivers (C/Q and DO/DI), selectable driver current limits, and overcurrent protection to further reduce power dissipation for small sensor applications.

Most IO-Link transceivers from ADI are currently available in compact TQFN and WLP packages. The MAX22513, for example, is offered in a WLP package and reduces the solution footprint by up to 50% compared to competitor parts. Additionally, with higher absolute maximum ratings and integrated surge protection, external protection components can be smaller.

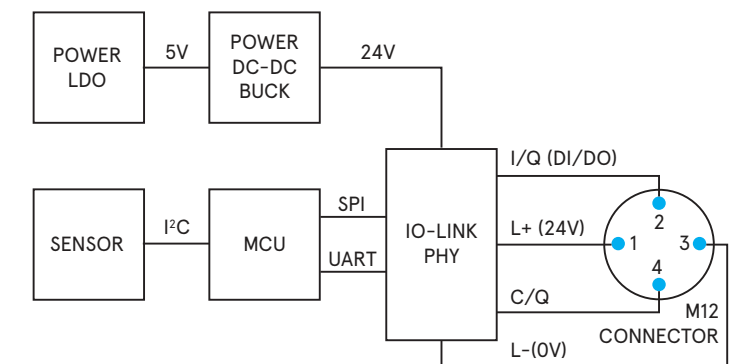


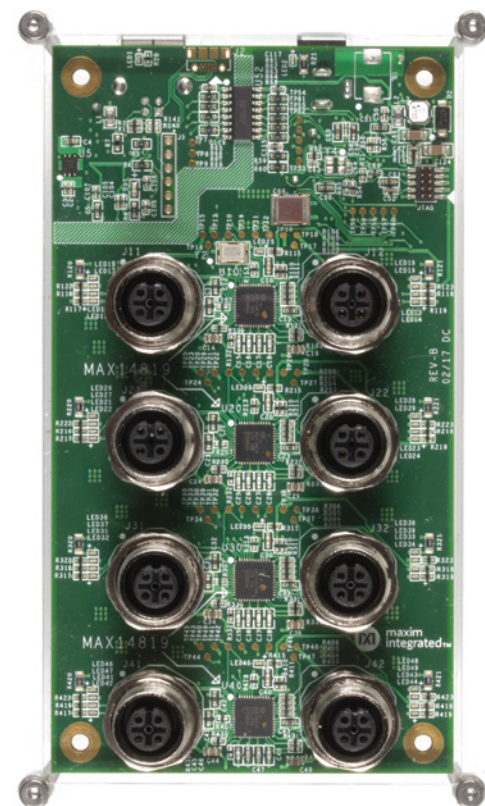
Figure 2. Building Blocks of an IO-Link Sensor

## IO-LINK MASTER DESIGN OBJECTIVES

When designing an IO-Link master solution, there are common system design questions that must be considered including the number of IO-Link ports, whether ports should be Class A or Class B, what miswiring cases should be accommodated for overvoltage conditions and/or reverse polarity, whether the PCB design be modular and able to accommodate different port counts, how much current the L+ supply should provide, the basic form-factor, and EMC compliance.

One example of an IO-Link master is the MAXREFDES145# eight-port IO-Link master reference design (Figure 3).

The design team chose to create an 8-port master due to the popularity of the configuration. The MAXREFDES145# utilizes the MAX14819 dual-channel IO-Link master transceiver and an Arm Cortex-M4 microcontroller. The reference design fits on a single 5in. x 3in. (127mm x 76mm) PCB. ADI partnered with TEConcept to supply IO-Link-compliant software stack. The MAXREFDES145# includes a TVS diode at each of the IO-Link ports and is tested to IEC 610004-2 and IEC 610004-5 for transient immunity to ESD and surge immunity.



**Figure 3.**  
MAXREFDES145#  
8-Port IO-link  
master reference  
design

## IO-LINK SOLUTIONS

To demonstrate transceiver performance, and provide quick and easy evaluation and prototyping for its customers, ADI has a comprehensive collection of IO-Link master and sensor/device reference designs available.

The MAXREFDES145#, discussed above, is an eight channel IO-Link master reference design. This reference design meets the requirements for a standard IO-Link master (including the ability to communicate at all of the data rates, as well as meeting EMC requirements).

Similar to the MAXREFDES145#, the MAXREFDES165# is a four channel IO-Link master using the MAX14819.

ADI IO-Link reference designs include circuits ranging from simple sensor measurements (for example, temperature, optical, and distance), to more complex devices including a digital input hub and a solenoid actuator. Table 1 shows a complete list of available IO-Link reference designs.

REFERENCE DESIGN	IO-LINK TRANSCEIVER	SENSOR/ IO ICs	DESCRIPTION
<b>IO-LINK DEVICE</b>			
MAXREFDES37	MAX14821	MAX14821	IO-Link Quad Servo Driver (TMG)
MAXREFDES42	MAX14821	MAX31865	IO-Link RTD Temp Sensor (IQ2)
MAXREFDES163	MAX14839	MAX14839	Binary Industrial Magnetic Sensor
MAXREFDES164	MAX14828	MAX31875	IO-Link Local Temp Sensor (TMG and TEConcept)
MAXREFDES171	MAX22513	MAX22513	IO-Link Distance Sensor (TMG)
MAXREFDES173	MAX14827A	MAX31875	IO-Link Local Temp Sensor (IQ2)
MAXREFDES174	MAX22513	MAX22513	IO-Link Distance Sensor (IQ2)
MAXREFDES176	MAX22515	MAX22190, MAX22192	16-Channel Digital Input Hub (TMG)
MAXREFDES177	MAX22515	MAX22000	Universal Analog IO (TMG)
MAXREFDES278	MAX22514	MAX22200	8-Channel Solenoid Actuator (TMG)
<b>IO-LINK MASTER</b>			
MAXREFDES145	MAX14819	MAX14819	8-Port IO-Link Master (TEConcept)
MAXREFDES165	MAX14819	MAX14819	4-Port IO-Link Master (TMG)

**Table 1.** IO-Link Reference Designs

## CONCLUSION

IO-Link is a powerful technology that plays an increasingly pivotal role in industrial automation. As a smart technology, IO-Link will not only save manufacturers billions of dollars every year but will also expand new markets for more customization of products. If you are involved in any form of industrial automation, integrate IO-Link technology into your products and watch as it continues to unleash the true power of Industry 4.0 and changes the way we think of manufacturing.

*To learn more about Maxim Smart Industrial Automation Solutions,*

[CLICK HERE](#)

# NanoPower On/Off Controller with programmable sleep time for battery-powered equipment

- ▷ Extends battery life up to 60%
- ▷ Consumes only 30 nA in timer mode and 10 nA in shutdown mode



SEE **MAX16163**



The DNA of tech™

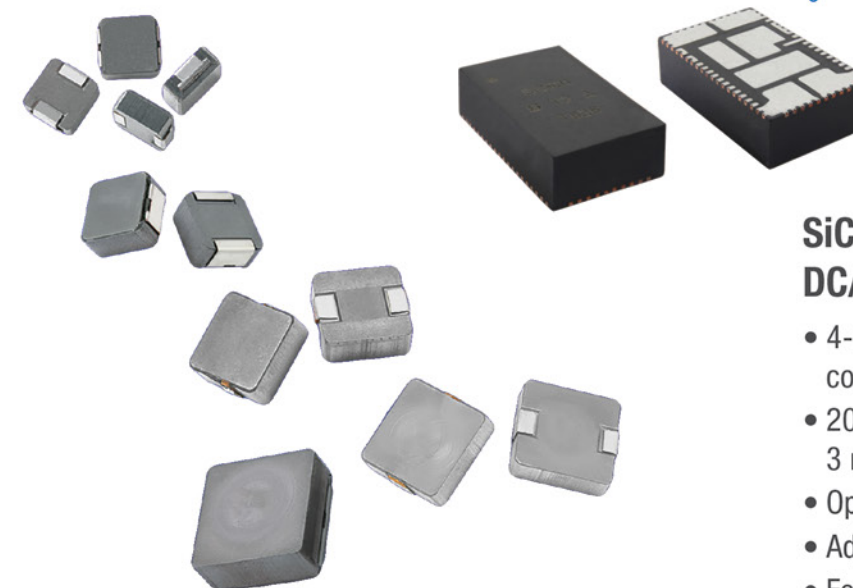
## The DNA of tech™ Makes Computing on the Edge More Intelligent

Sensors, passives, discrete semiconductors, and integrated modules from Vishay are key building blocks for IoT-enabled industrial automation systems that improve efficiency and effectiveness across factory operations.

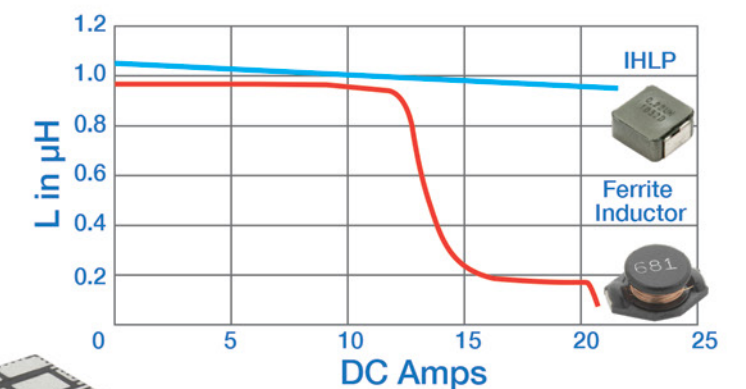
### Featured Products for Computing on the Edge

#### IHLP® Commercial Inductors, High Saturation Series

- 10 footprints and over two dozen profiles in five different core materials to meet nearly every power supply requirement
- High frequency operation out to 5 MHz, excellent saturation
- Compact composite inductor for high efficiency DC/DC conversion



#### Saturation – IHLP vs. Ferrite Inductor



#### SiC931 microBRICK® DC/DC Regulator Module

- 4-in-1 easy to use module with onboard DC/DC controller + 2 MOSFETs + inductor
- 20 A of continuous current in a 10 mm x 6 mm x 3 mm low profile MLP package
- Operation from 4.5 V to 18 V input voltage
- Adjustable output voltage down to 0.6 V
- Four programmable switching frequencies available: 600 kHz, 1 MHz, 1.5 MHz, and 2 MHz

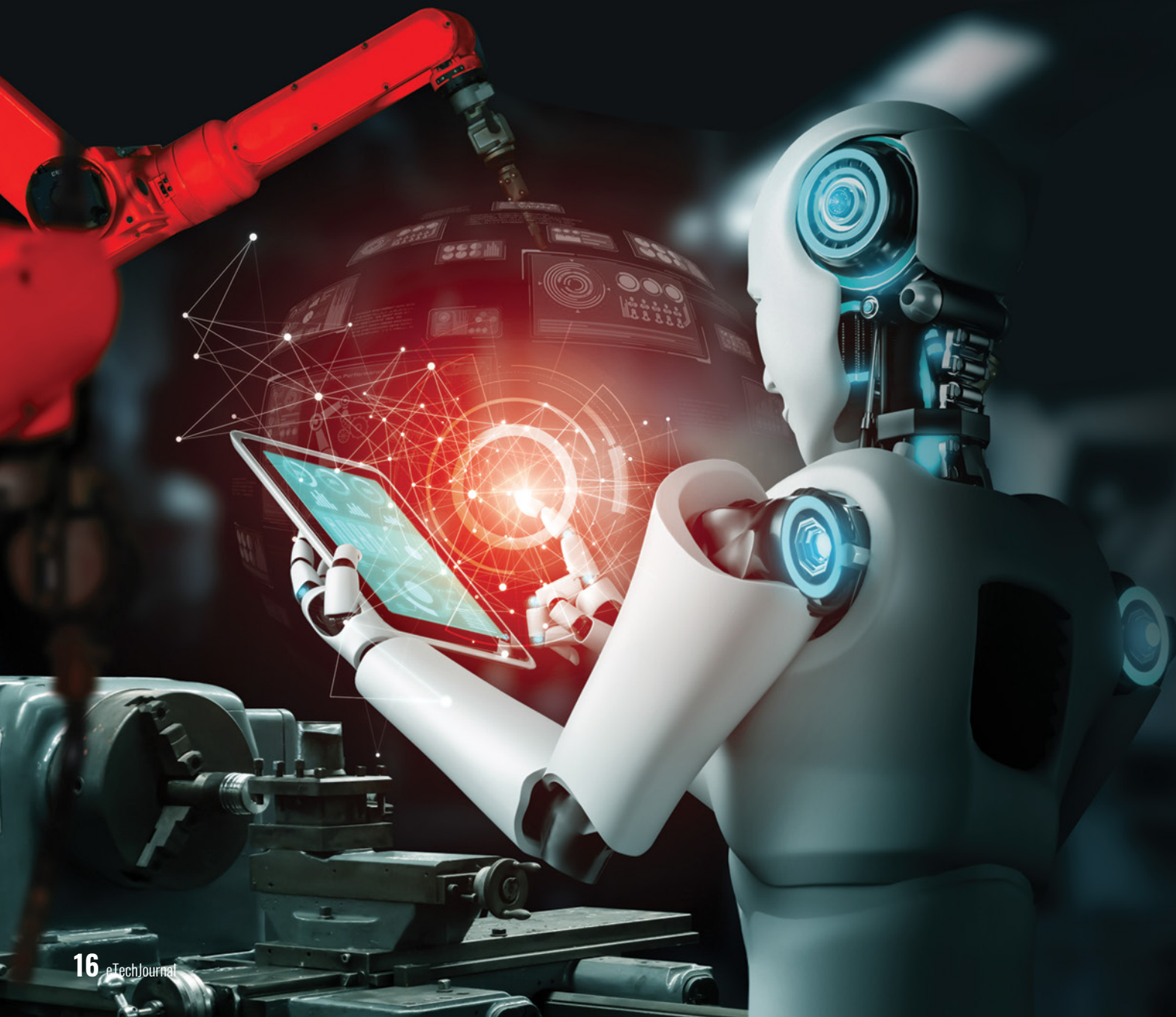
[www.vishay.com](http://www.vishay.com)

© 2022 VISHAY INTERTECHNOLOGY, INC. ALL RIGHTS RESERVED.  
AD28429058





# AUTOMATE AWAY COMPLEXITY & REPETITIVENESS WITH ROBOTIC PROCESS AUTOMATION



R&D engineers debugging and verifying circuits can now leverage interactive automation without the knowledge, complexity, and effort required to develop custom scripts using SCPI or device-specific driver commands.

## AGILE DEVELOPMENT LIFECYCLE DEMANDS A MORE SYNERGISTIC APPROACH TO AUTOMATION.

Automation layered on top of metrology



And infused in the workflow



In the development journey one of the hardest things to determine is when is something good enough, such that you can call it done, ready to ship and ready to operate!

In reality, nothing can ever be perfect, and so there are ways to recover when something shipped turns out to be not good enough. But you'd rather get to a stable shipping product quickly.

As a Hardware Design Engineer, you focus on getting your product completed and shipped out to help customers, in the shortest possible time.

Debugging and verifying circuits typically requires a range of test instruments. You probably need to work with a mix of instruments spanning generations, from basic user interface to sophisticated interactive screens.

PathWave Instrument Robotic Process Automation (RPA) has the ability to automate most instruments that can be accessed remotely. There is no need to search for drivers or integrate APIs. RPA's OCR capability helps to recognize your interactions with the instrument graphical user interface.

If you map out your workflow, there are opportunities at every stage to offload tasks to PathWave Instrument RPA. The decision of what tasks to automate and at what stage on your automation journey is entirely yours.

**Leverage PathWave RPA's near universal connectivity capabilities for instrument and DUT control**

PathWave RPA has the ability to record user interactions with most test instruments and execute automatically the next time.

You can set parameters and have RPA iterate them for you. Multiple recording sessions can be dynamically stitched on-the-fly to meet your sleuthing and debugging needs.

You could have a waveform generator, a signal source and an analyzer integrated into a solution, that could all be integrated within an RPA workflow. Further, you could integrate DUT control to RPA for more comprehensive automation.

## BENEFITS AND VALUE OF PATHWAVE INSTRUMENT RPA



### Automate Away Complexity & Repetition

- > Repetitive tasks made easy with RPA
- > Remotely access instruments anywhere



### Parameterize UI Interaction

- > Maintain full flexibility and control with on-demand automation



### Accelerate Time to Results & Insights

- > No-code multi-instrument orchestration with DUT Control
- > Near-universal connectivity to integrate across applications and instruments



### Intuitive Learning Product

- > Learn at your own pace at RPA's Resource Webpage
- > KeysightCare, access to technical experts

### Leverage RPA's capabilities for diverse instrument control

Order Number	Number of Concurrent Instrument / DUT Control	Subscription License Type	Minimum Number of Licenses
BV7003A Advanced	5	Node Locked	1
BV7005A Enterprise	8	Floating Worldwide	10



Watch our intern Celeste use RPA to automate a Keysight digital multimeter, a robotic arm and an external application. RPA enables you to remotely access, orchestrate and control your measurement setups anywhere in the world with its simple no-code, one-button record and playback operation.



You will of course need to start any sleuthing and debugging work by first setting up your testbench on-site. Once you have physically connected your DUT to the required instruments, you can choose to continue to work on-site or access your DUT and instruments remotely.

You can control and orchestrate multiple sessions with instruments and DUT remotely from home. RPA is a simple, great and affordable utility that makes it easier for you automate repetitive tasks without any coding, and from anywhere with internet connection.

**PathWave Instrument RPA is instrument and platform agnostic.**

**RPA can work with most instruments and applications that you can access remotely and interact with over a GUI (via RDP, VNC or URL for web-based interface such as LXI).**

**Apply RPA's remote automation capability to drive workflow continuity today!**

PathWave Instrument RPA is a first step into your fascinating journey with Intelligent Automation. The possibilities are immense.

Once you have the basics going, and are able to connect a DUT, configure various parameters and acquire results, you will start seeing the benefits of repetitive work being automated.

Automate-away complexity and repetition, and interact with instruments anywhere with RPA. Let RPA free you up from repetitive tasks to focus on what matters most.



## CONCLUSION

Keysight PathWave Instrument RPA is a simple interactive no-code automation companion for R&D Engineers to accelerate debugging and product development.

**To learn more about PathWave Instrument RPA and start your free trial today,**

[CLICK HERE](#)

# PATHWAVE

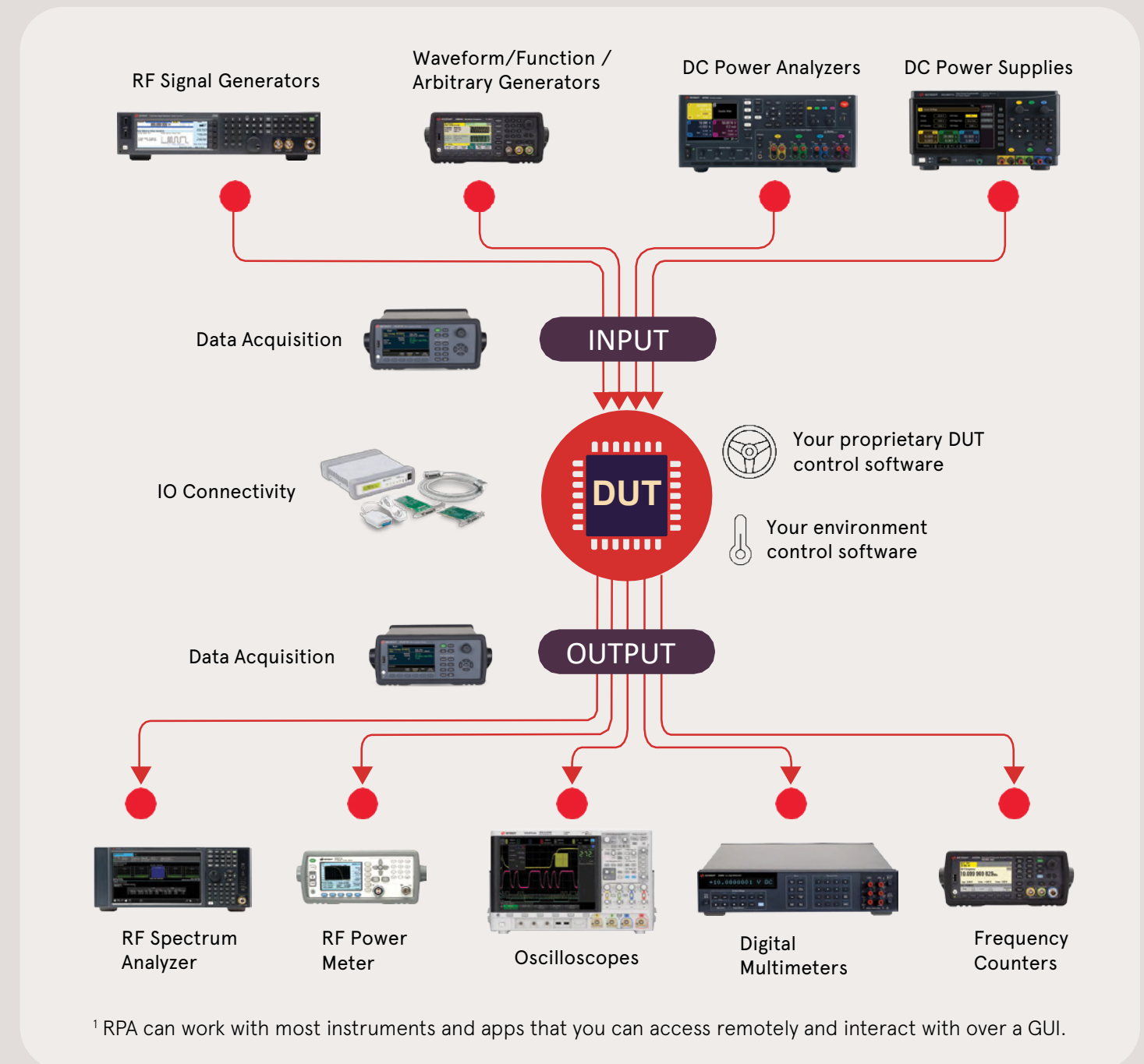
# Instrument RPA

PathWave Instrument RPA is a test **companion** to take repetitiveness out of your daily workflow.



Near-universal connectivity for no-code orchestration across instruments and apps <sup>1</sup>

- Remote Desktop Protocol (RDP)
- Virtual Network Computing (VNC)
- Direct URL / Internet Browser
- Direct Executable (EXE)



<sup>1</sup> RPA can work with most instruments and apps that you can access remotely and interact with over a GUI.

**Infuse automation** into your workflow. Speak to your Sales Representative today on how you can accelerate R&D with **Keysight PathWave Instrument RPA**.

# LEVERAGE THE INTERNET OF THINGS TO SET UP A SMART FACTORY

Manufacturers today are under tremendous pressure from management and customers to deliver high quality products and services at low costs in a minimum amount of time.

Today's market leaders rightly believe that return on their investment (ROI) is multidimensional, determined by not just costs, but also measures of customer satisfaction and more. Companies are turning to the Internet of Things (IoT) to collect accurate data and convert it into actionable information to help add this extra dimensionality to ROI calculations.

IoT is creating new opportunities for companies to enhance their services, gain business insights from accurate and timely data, improve business processes and differentiate their offerings. This white paper describes the value of IoT for manufacturing and defines an ROI model for building a business case and tracking results related to IoT initiatives.

## INDUSTRY 4.0

*IoT has the potential to change the face of the manufacturing sector, so much so that it has been called the fourth industrial revolution. If the pace of advancement in technology is anything to go by, intelligent factories will soon become the norm, rather than the exception. The four main factors of a smart factory are IoT, data, automation and precision:*

### THE INTERNET OF THINGS

IoT is the torchbearer of the smart factory. More than just sensors and other "things," it is the connection of the things to each other in order to facilitate the collection and transfer of data. Multiple types of sensors with the ability to connect to the cloud are installed in the factory to gather data which helps to optimize the factory.

### DATA

Data plays an important role in a smart factory, making it possible for managers to gain insights for streamlining manufacturing processes, increasing ROI, and more. IoT can also contribute to an enterprise's big data initiatives, with the ability to collect and transfer massive amounts of structured and unstructured data to save in a centralized location for real-time or future analysis.

### AUTOMATION

The IoT system in a factory setting can work autonomously to drive and monitor production with minimal human intervention. And equipment longevity is improved by IoT-enabled predictive maintenance, where IoT sensors can detect faults on the basis of the data collected and independently make decisions to stop faulty equipment before it fails.

### PRECISION

IoT sensors and other equipment are designed to sense and measure to an incredible level of precision, making them appropriate for almost any factory application, no matter the size and no matter how exacting.



## INDUSTRIAL AUTOMATION

IoT is ideal for increasing the level of automation in today's factories. For manufacturing companies that have already installed sensors, actuators and other low-level devices in their existing industrial automation systems, upgrading and retrofitting IoT-enabled devices is an easy step.

These companies can take advantage of the increase in network speeds and memory size delivered by today's commercial off-the-shelf sensors and other hardware along with well-established cloud platforms. The technology today is robust enough to not hamper the design of the systems as was the case in the past. This will give plant managers new levels of control and insights regarding the production floor.

***The key to the success of industrial automation is making use of the data that is gathered.***

It's not enough to just collect data. The key to the success of industrial automation is making use of the data that is gathered. The IoT-enabled industrial automation networks collect data and then transfer it to the cloud or to an internal datacenter. There, Hadoop and other technologies are implemented to apply data science techniques and predictive models to analyze the data into useful information.

Another reason for manufacturers to adopt IoT in their factories is to delay or prevent obsolescence.

Many industrial automation systems in factories today will outlive vendor support. By upgrading to IoT systems, plant operators can extend both the functionality and the lifespan of these systems. And as the cost of internet bandwidth and storage has been steadily decreasing, companies can now store terabytes of data very inexpensively compared to even a few years ago.

IoT takes industrial automation even further by interfacing with robust machine-to-machine (M2M) systems. This covers a broad range of technologies used to enable networked devices to exchange data with each other and perform actions without human assistance. M2M technology has applications in almost every area of manufacturing including ensuring plant and personnel safety.

For example, the company's safety engineers can establish safety limits for each piece of equipment. If IoT sensors detect a rise in equipment temperature that brings it to that safety limit, the system will record this fact and it will trigger an immediate shutdown of the affected equipment. Or if the company does not want to implement an automated shutdown system, it can set up the sensors to transmit data to key personnel with remote monitoring ability on their desktops, tablets or other devices. These employees can then send instructions to the machine to shut down, reduce its production rate or carry out any other function in order to take care of the safety issue.

## THE IOT VALUE PROPOSITION

IoT also delivers value in areas other than on the factory floor, including remote monitoring, remote service, usage analysis, ERP/CRM integration and much more.

***Smart, connected products enable remote monitoring and servicing that drive both a reduction in the costs of service and an improvement in the level of service. Analysis of connected product data can improve business decisions, product design and manufacturing processes.***

Core business processes like billing, field service, product registration, compliance, consumable management, recalls and warranty management can all be improved with connected product data. On the other side of the IoT market, the selling and marketing of connected products can deliver a competitive advantage and drive revenue growth.

Following are examples of demonstrating the value that can be derived from enabling IoT in your company

## BUSINESS BENEFITS

### PRODUCT TRACKING

IoT-connected sensors can help manufacturers easily track products such as raw materials, finished goods, parts and more. Real-time updates provided by the system can allow companies to optimize logistics to streamline and accelerate their processes and cut unwanted costs. Tracking products in real time allows companies to ensure the quality of their finished goods, maintain inventory levels and even prevent theft.

*For example, a manufacturing company required an advanced system for tracking their raw materials while they were being transported. Using RFID tags, the company was able to track the exact location of the materials, allowing them to prepare for production while they were enroute and be ready for production immediately after they arrived. Real-time product tracking not only helps the company improve its efficiency, but also helps them save on time and costs.*

### PREDICTIVE MAINTENANCE

IoT can help you accurately predict the maintenance cycle of your devices, machines and their components by analyzing historical data. Analysis of connected product data can also uncover patterns that are early indicators of failures, allowing you to initialize service. Rather than performing preventive maintenance on a calendar basis when it may not be needed, companies can instead track exactly how much a device has been used to determine whether it's time for service. This eliminates unnecessary preventive maintenance calls and premature repairs or component replacement. Service reps can also perform preventive maintenance during scheduled calls, reducing unplanned and planned downtime and customer interruption. This predictive maintenance knowledge can then feed increased revenues by providing increased uptime with premium SLA pricing.

*For example, IoT-connected vibration and noise sensors on machines and other high-end assets collect data regarding the working of the machines and their components. The collected data is analyzed in real-time to determine when machine failure is likely to happen or predict the breakdown of a machine component or part. This helps the factory to carry out maintenance in advance to avoid expensive downtime.*

### IMPROVED PRODUCT DESIGN

The understanding gained from real end-user behavior and usage patterns can be combined with IoT-collected data to yield information valuable for product designers. The company can combine this data with real-world customer feedback to define next-generation products that will expand market share.

*For example, a manufacturer of smart watches installed sensors to collect information about consumer usage. They discovered that many users were rough on the watches, resulting in damage. This insight prompted the company to change the material used to design their watches to make them capable of enduring rougher usage.*

### IDENTIFICATION OF QUALITY ISSUES

By looking at trends across multiple systems, you can reduce costs by identifying quality issues. Whether from design flaws in parts supplied by third parties or within your own manufacturing processes, looking at the trends helps you to understand what is causing downtime for your customers. Ultimately this can allow you to prevent downtime, reduce repair costs, or streamline the recall process. If problems are of a more serious nature and are still part of the current manufacturing process, IoT-collected usage data may trigger the need to change your processes.

*For example, a manufacturing unit unwittingly produced faulty goods that were undetected in the testing stages. However when customers started to use them, the attached noise sensors immediately sent notifications to the manufacturer about out-of-spec noise levels. This data prompted the company to test the product again, and they found the problem. The company immediately recalled all of its batches, the fault was rectified in the manufacturing unit and replacement products were delivered to their customers.*

### KEEPING ENERGY CONSUMPTION IN CHECK

Energy consumption can be a major expense in a factory, so monitoring is important to help minimize waste and thus reduce costs. IoT-connected components monitor fuel levels and more to find out how much power or fuel is being used by certain equipment, and the collected data can be analyzed to check if it is more than the required amount.

*For example, a company decided to use a smart power monitoring system to detect how much power is used by every machine in the factory. When more power than necessary is detected going to a piece of equipment, the system alerts technicians, who can ensure the machine is operating to specifications or that the wiring is correct.*

### DATA INTEGRATION AND BUSINESS PROCESS EFFICIENCY

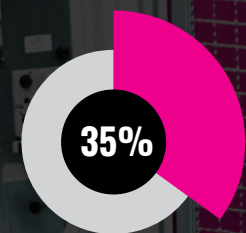
The value of the real-time, accurate data collected by the sensors and systems in an IoT-enabled smart factory can add value to processes almost everywhere in a business. This data can be pulled into data warehouses to be used in systems such as customer relationship management (CRM) and enterprise resource planning (ERP) systems for financial or other analysis. Real-world data on usage patterns or equipment issues can be integrated into quality assurance (QA) or product lifecycle management (PLM) systems, helping improve customer satisfaction and streamline beta programs.

*The table on page 10 shows business processes that can be impacted by IoT data and the benefit that can be derived.*

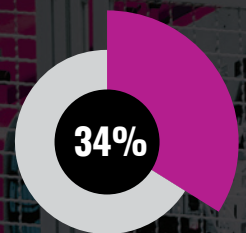
## ESSENTIAL COMPONENTS FOR IOT IN MANUFACTURING

While machine-to-machine communication has been around for a while now and a number of manufacturers have leveraged it, IoT remains a new concept due to its components. With advancement in technology, this industry is growing quickly and offering essential components at relatively low costs, making it easy for all types of manufacturers to adopt it.

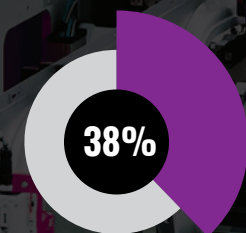
BUSINESS PROCESS	MEASURE	BENEFITS
Customer service	Length and frequency of support calls	Effective troubleshooting and CRM efficiency increased
Field service	Time to resolution	Proactive creation of field service request with accurate data and health status
Warranty management	Number of warranty services, warranty costs	Reduction in warranty service costs and data on warranty compliance
Recall management	Support cases of recalled products	More efficient recalls with accurate data on which product needs to be recalled
Consumable management	Consumable revenue	Increase in sale of consumables
Compliance	Cost of compliance	Reduced costs through more efficient auditing of interactions with machines and humans
Configuration management	Cost of configuration management	Accurate data about installed equipment and configuration



35% of manufacturers in the US have started utilizing data collected by smart sensors to streamline the manufacturing process



34% of manufacturers currently believe that it is critical to adopt the IoT to optimize operations



About 38% of them have already installed sensors in their goods to allow users to gather sensor-generated data

Source: [www.themanufacturinginstitute.org](http://www.themanufacturinginstitute.org)

### SENSORS

Sensors are the driving force behind the IoT ecosystem in manufacturing. They collect and consolidate data in real time and have the ability to integrate with direct database systems, legacy ERP systems or data warehouses.

### DATA INTEGRATION AND BUSINESS PROCESS EFFICIENCY

Internet connectivity has become more reliable and affordable, allowing manufacturers to deploy it in their units. Companies interested in implementing IoT in their factories have a whole range of network standards to choose from. Existing standards such as Bluetooth, Wi-Fi, BLE, RFID, ZigBee, Z-wave and IPv6 are now widely used in IoT-enabled factories. Other emerging standards promoted by some device manufacturers include 6LoWPAN, Weightless and 802.11ah. Choosing the right networking standard depends upon several factors such as device compatibility, your existing infrastructure and your IT team's expertise with the standards.

### IOT PLATFORM

The most important part of a smart factory is the IoT platform. Before implementing an IoT integration plan, it is very important to ensure that you have a compatible open architecture in place and that any M2M applications you consider meet your digital business requirements. Take a strategic approach to your IoT initiative to avoid such critical issues as a security breach or interruption in connectivity. Choosing an appropriate IoT platform is an integral step in an IoT strategy, as it will facilitate monitoring and control different data points from a variety of sensors. An IoT platform connects access points and data networks to end-user applications, allowing you to automate processes and analyze data. In other words, IoT platforms act as middleware solutions that connect the data collected at the edge to the user-facing software-as-a-service (SaaS) or mobile app. An IoT solution will include many functions, such as:

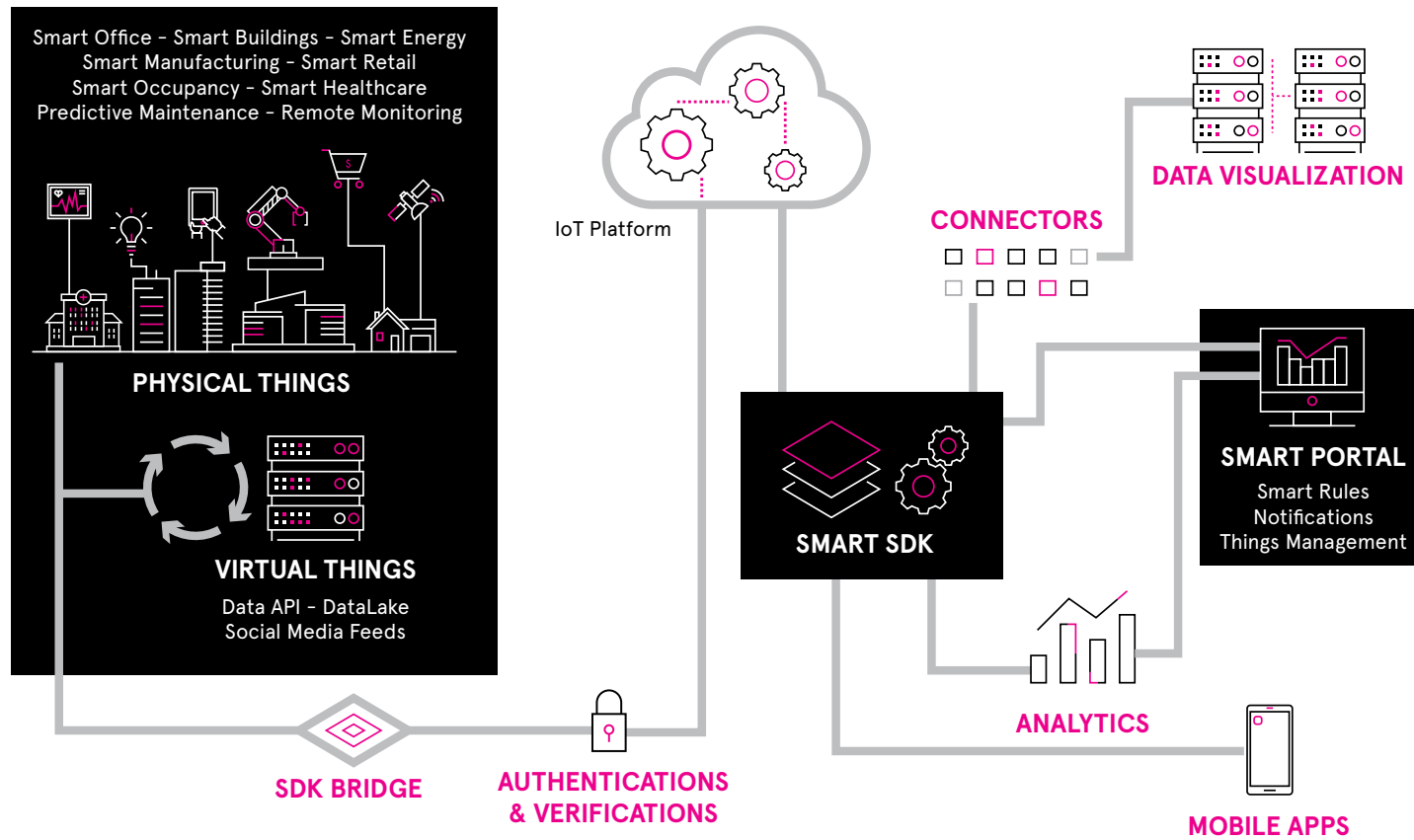
- Sensors and controllers
- A gateway device to collect data and send them back to the server
- A communication network to transmit data
- Data analytics and data visualization software
- A user facing application

### THE IOTCONNECT PLATFORM

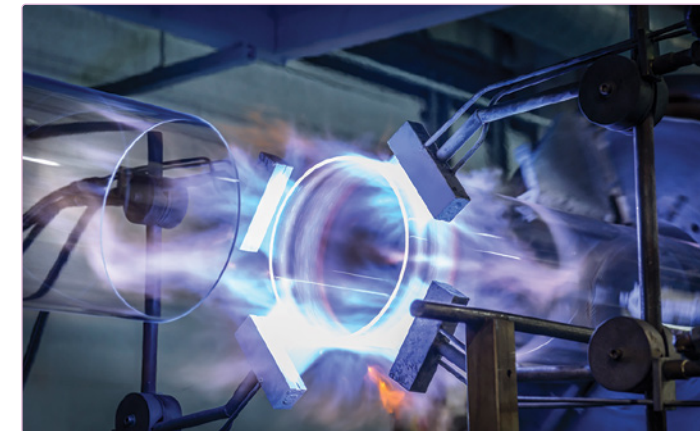
IoTConnect is a multi-purpose middleware platform developed on open source technologies. As shown in the figure below, this horizontal IoT platform-as-a-service (PaaS) system allows for device communication and management, data storage, app creation and enablement, robust security protocols and implementation of data science methodologies. IoTConnect gives factories the following capabilities:

- Manage multiple connected devices
- Set up cross-device connectivity
- Data visualization reports
- Perform remote device provisioning and configuration
- Perform real-time device monitoring - Distribute over-the-air firmware updates
- Create cloud services for smart products
- Collect and analyze sensor data
- Analyze user behavior and deliver targeted notifications

The main benefits that factories gain from IoTConnect include integration, deployment, security, automation, interoperability, and access.



FLAWLESS INTEGRATION	FASTER DEVELOPMENT	OPTIMUM SECURITY	AUTOMATION	INTEROPERABILITY	CENTRALIZED ACCESS
Enterprise grade integration mechanisms ensure easy adaptation of existing workflows, business processes and information systems.	Create new processes with ease and add business applications through common interfaces for faster development.	Secure data received from all sources of your IoT ecosystem with state-of-the-art data security systems	Operate and maintain device and data tasks by automating business processes and save management costs.	Accelerate time to market, reduce cost deployment and maintenance costs of IoT solutions by utilizing interoperable technologies.	Single point for adapting protocols and data models for gathering the information and managing the communications.



### DATA ANALYTICS AND VISUALIZATION

Data analytics is the science of analyzing large amounts of data to uncover patterns and other insights that may be overlooked by humans. The concept of analyzing big data is not new, but the availability of cloud-based storage and analytics tools such as Microsoft Azure and Amazon Web Services among others means that even medium-sized manufacturers can now take advantage of data analytics. The data that has been gathered needs to be converted into easily understood graphs and reports. With interactive data visualizations you can conceptualize future business strategies by drilling down into charts and graphs. Data visualization tools are used by companies to identify new patterns by explaining concepts clearly and deeply. Some of these tools are Tableau, D3.js, Power BI and R.

Tableau is an effective tool to quickly create interactive data visualizations and to explore and find patterns with various combinations. Its simple interface can be used by anyone as this tool is designed to be used by developers as well as non-developers.

D3.js is a JavaScript library that is used for data visualization. It is used to convert unstructured data collected from various sources, such as government databases, social networking, eCommerce portals, etc., into a more usable or productive form.

Power BI allows developers to create accurate visualizations and display data in different ways with minimum effort. The Power BI Desktop includes a variety of standard visualizations, including a range of reports that companies usually need.

R is a popular statistical language that is used with Power BI as well as Tableau to perform statistical and predictive analytics. This includes statistical tests, time-series analysis, linear and nonlinear modeling, classification, clustering and more.

## BUSINESS CASE OF IOT IN MANUFACTURING

Every manufacturing company operates production lines that consist of many critical processes, many of which can benefit from IoT. For example, manufacturing controls require continuous measurement of environmental variables such as temperature and pressure. Compliance regulations make it necessary to provide safe working conditions for its employees such as controlled noise levels, water quality and more.

### TYPES OF SENSORS

Sensors throughout the production unit monitor critical processes, environmental variables and parameters that affect product quality and working conditions for the employees.

These sensors include:

- Temperature sensors (manufacturing process)
  - Carbon emission sensors (manufacturing process, environmental emission)
  - Humidity sensors (storage/warehouse conditions)
  - Noise sensors (worker conditions, compliance)
  - Vibration sensors (machine monitoring)
  - Micro sensors and equipment tags (manufacturing process, machine monitoring)
  - Occupancy sensors (resource management, workers' safety)
- Typical occupancy sensors include: / Passive infrared sensors (pir) / Ultrasonic sensors / Microwave sensors / Motion sensors (workers' safety) / Fire and smoke sensors (workers' safety, machine monitoring)

### CHOOSING THE RIGHT IOT PLATFORM

The gap between the device sensors and data networks is bridged using an IoT platform with the help of back-end applications to manage the data generated by hundreds of sensors. Choosing the right platform can be challenging as there are many device clouds in the market today which are often classified as IoT platforms.

### WEB AND MOBILE APPLICATION

This is an intelligent dashboard that is the part of the system most visible to you and gives you direct access to information as well as analytics, graphs, and historical data. Mobile applications give you real-time updates by means of alerts and notifications, and with smart sensors you can send commands back to the devices to remotely operate them. This makes it extremely easy for you to maintain your policies and compliance standards.

## THE IOT-ENABLED SMART FACTORY

To complete the picture, we will describe a working factory featuring all the advanced components of IoT. A smart factory leveraging IoT will install multiple sensors to detect temperature, humidity, noise, light, vibrations and volatile organic compounds in its factory. The factory also has specialized sensors to track the working of all of its machines and equipment, to identify the location of vehicles which carry raw materials and finished goods as well as to manage the supply chain.

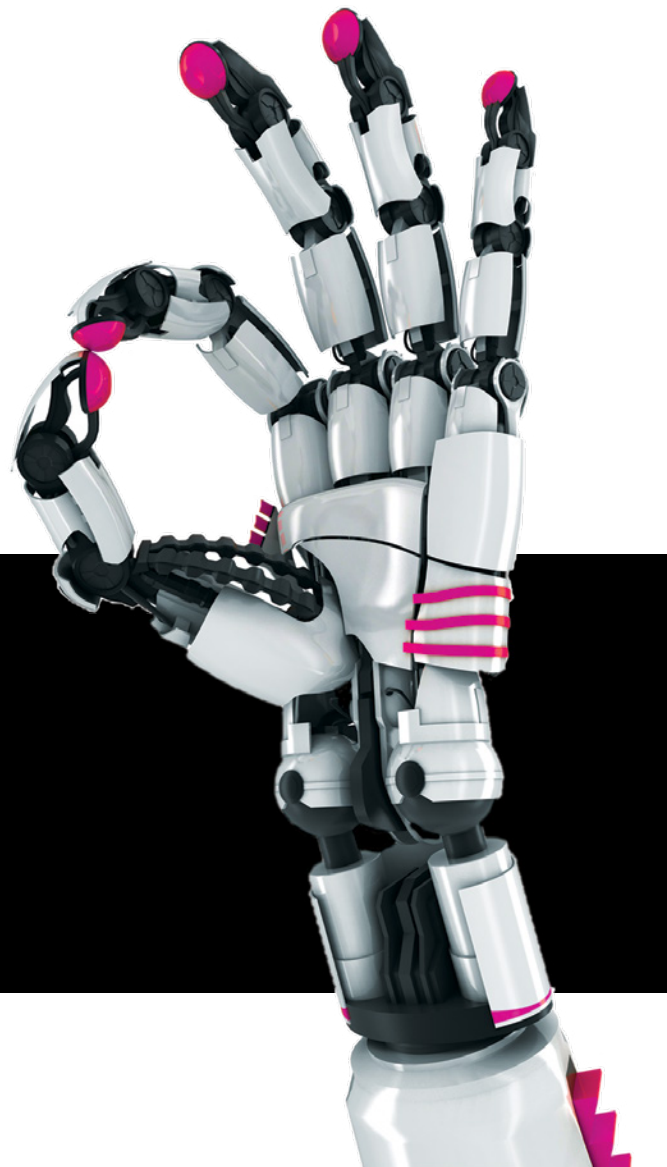
The data collected by all these sensors is transmitted to a cloud-based storage system. There, principles of data science are applied in order to get meaningful information and gain insights that are presented in the form of interactive reports and charts. Managers and other authorized employees access these data visualizations from the cloud to supervise and manage the working of their respective departments.

This information is used to maintain the right temperature, humidity, light and noise levels in the manufacturing unit, along with ensuring compliance with safety standards. The IoT and data science ensure that any defects are detected in the early stages and downtime can be prevented, and the machinery is easily monitored and maintained if faults are detected.

Vehicles are monitored in real-time to ensure that the finished goods are delivered to distributors and retailers on time. Employees are made aware of the arrival of raw materials well in advance and are prepared to start production right away in order to avoid wasting time. New or alternative routes are suggested to drivers in order to ensure that they reach their destination without wasting time and fuel.

Managing the inventory is easy for the manufacturer, as they know exactly when to order required raw materials just in time, avoiding costs for storing goods any longer than necessary. Low stock will trigger order reminders to avoid delays in the production of goods. IoT also connects the factory to warehouses, distribution centers, retailers, suppliers and customers to facilitate supply chain management by allowing real-time information sharing.

The smart factory successfully lowers costs by avoiding fuel and power wastage. Downtime is decreased to a great extent, allowing uninterrupted production in the manufacturing unit. Moreover, sensors installed on the finished goods help identify faults in products, so that they can be rectified as soon as they are detected to decrease losses and offer quality products and services to consumers. The factory also saves on warranty management.



### CONCLUSION

IoT is a driving force for manufacturers today. Newark can be your technology partner and help you stay ahead of your competition in this fourth industrial revolution. With advancement in smart sensors and cloud technologies, companies can enjoy more intelligent service at a lower cost. The time is now to make your company smarter and more efficient than before. **The time is now to make your company smarter and more efficient than before.**

CLICK HERE

To learn more about our Smart Industrial Automation & Control solutions

# The Largest Online Community for Engineers

element14  
/ AN AVNET COMMUNITY

800,000+ members in over 48 countries

Join for **FREE** at [community.element14.com](https://community.element14.com)

**CONNECT** with a community of thousands of engineers and innovators from all over the world.

**LEARN** about the latest technology from industry experts, suppliers, independent sources, and user reviews.

**CREATE** your next electronics project and get access to 24/7 support to tackle difficult challenges.

**INSPIRE** and be inspired; share your latest work and help others to build a better connected world.



### Exclusive Features

- Join Design Challenges, Project14 competitions, and more
- Learn with Essentials Modules, eBooks, and Tech Spotlights
- Attend webinars and workshops from top suppliers
- Watch element14 presents Wednesday and Friday educational videos
- RoadTest current and trending new products
- Get access to Design Center, technical resources, and experts
- Find support for development tools and design softwares

### Popular Community Content

**FPGA Topics** – Explore the latest trends in programmable logic devices and access education, workshops, and webinars on FPGAs.

**Sensors** – Stay current with all of the latest products and innovation in Sensor Technology.

**Internet of Things (IoT)** – join the conversation on nodes, gateways, and the cloud—from selecting the right hardware to designing for safety and security.

Find out more @ [community.element14.com](https://community.element14.com)

Join the conversation  
Follow element14 on







# AUTOMATION POWER MODULES: TYPICAL FAILURE MODES AND HOW TO SOLVE THEM

## IGBT FAILURE ANALYSIS – FIRST AID FOR EMERGENCIES

Power modules are considered critical components that usually undergo a rigorous testing cycle in the design phase of the application. Field failures then often come as an unpleasant surprise and failure analysis is rarely straightforward but more often a detective game.

## FAILURE DESCRIPTION AND ANALYSIS

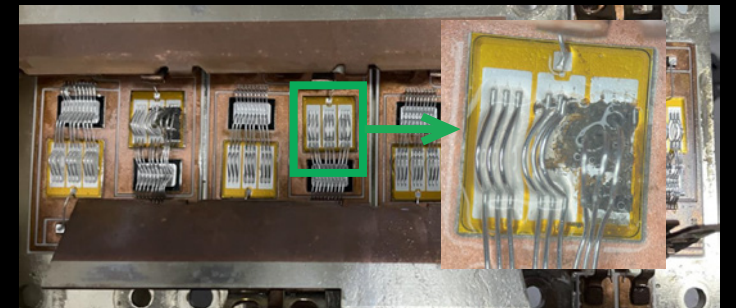
Opening up a failed IGBT-module often reveals one or several dies with black spots, which, under higher magnification are visible as molten layers of the chip's top side metallization. Generally, this is caused by either by current or voltage spikes, an explanation however too general to derive any further actions of how to prevent it from repeating. Naturally, the finger of blame is often pointed at the manufacturer and parts returned for further analysis.

On return and after visual inspection, the manufacturer would usually attempt to measure the static and dynamic electrical parameters and compare them with the specified values in the data sheet. Often however, the dies are degraded to an extent that this process yields either no or mostly inconclusive results.

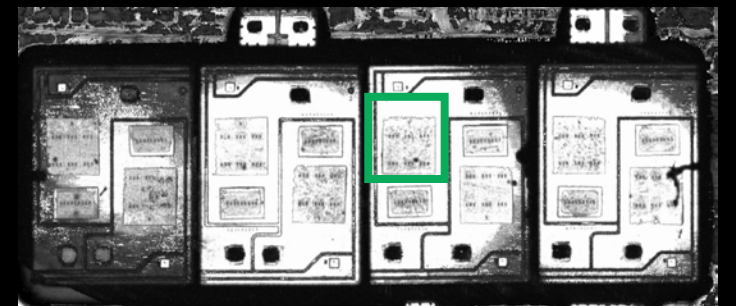
The next logical step is to check for manufacturing errors, especially by analysing the solder layers as voids here often directly lead to either bond lift-offs or in severe cases complete melting of the chip metallization. In this particular case however, Fig. 2 and 3 show no abnormalities in the solder connection.

Looking at modern production lines of IGBT-modules operated by StarPower and other leading manufacturers, this result is not surprising. In-line x-ray testing combined with automated optical inspection (AOI) finds and sorts out modules with out-of-spec solder connections before they can reach the customer.

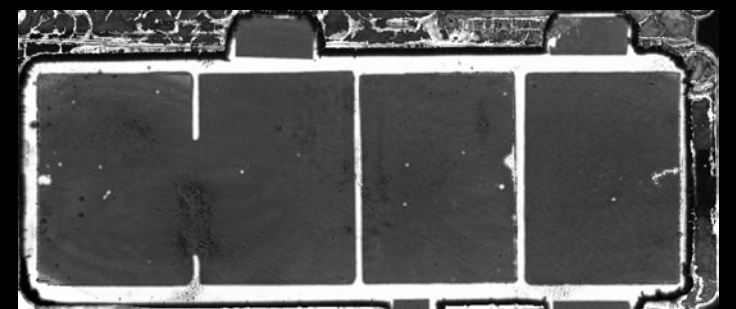
Scheduled shear tests verify the bond connection and every module is 100% tested on static and dynamic electrical parameters as well as isolation before it leaves the production line.



**Figure 1**  
Image of failed IGBT-die with molten top metallization

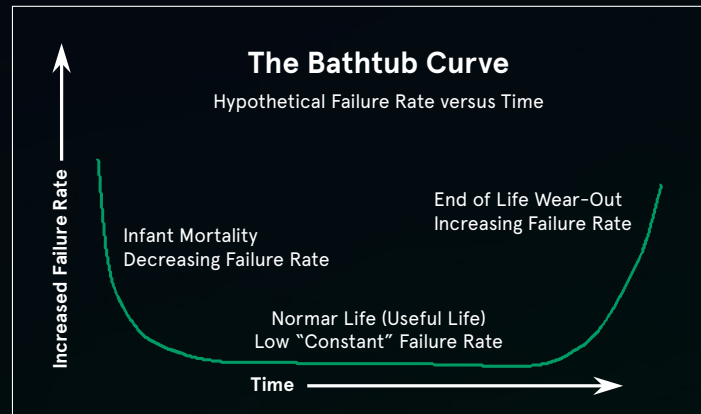


**Figure 2**  
Ultrasound analysis of solder connection between die and DBC



**Figure 3**  
Ultrasound analysis of solder connection between DBC and baseplate

## FINDING THE ROOT CAUSE



**Figure 4**  
Bathtub life cycle curve for technical applications,  
©www.weibull.com

Not uncommonly, the conclusion after 8D-analysis of failed modules in the field is that they worked within specification before leaving the factory of the module supplier, potentially even at assembly of the application but then failed in the field at some point after. Failures occurring only occasionally can be especially hard to identify often with no quick fix. Looking at failures over the life of the application, one often thinks about end-of-life wear-out failures after a significant time of operation.

To offer predictability and reliability in this part of the bath-tub curve (Fig. 4), module manufacturers perform process qualifications in the design phase of the module. These tests include mechanical stress, high temperature and humidity as well as power and thermal cycling assessments – often referred to as accelerated ageing.

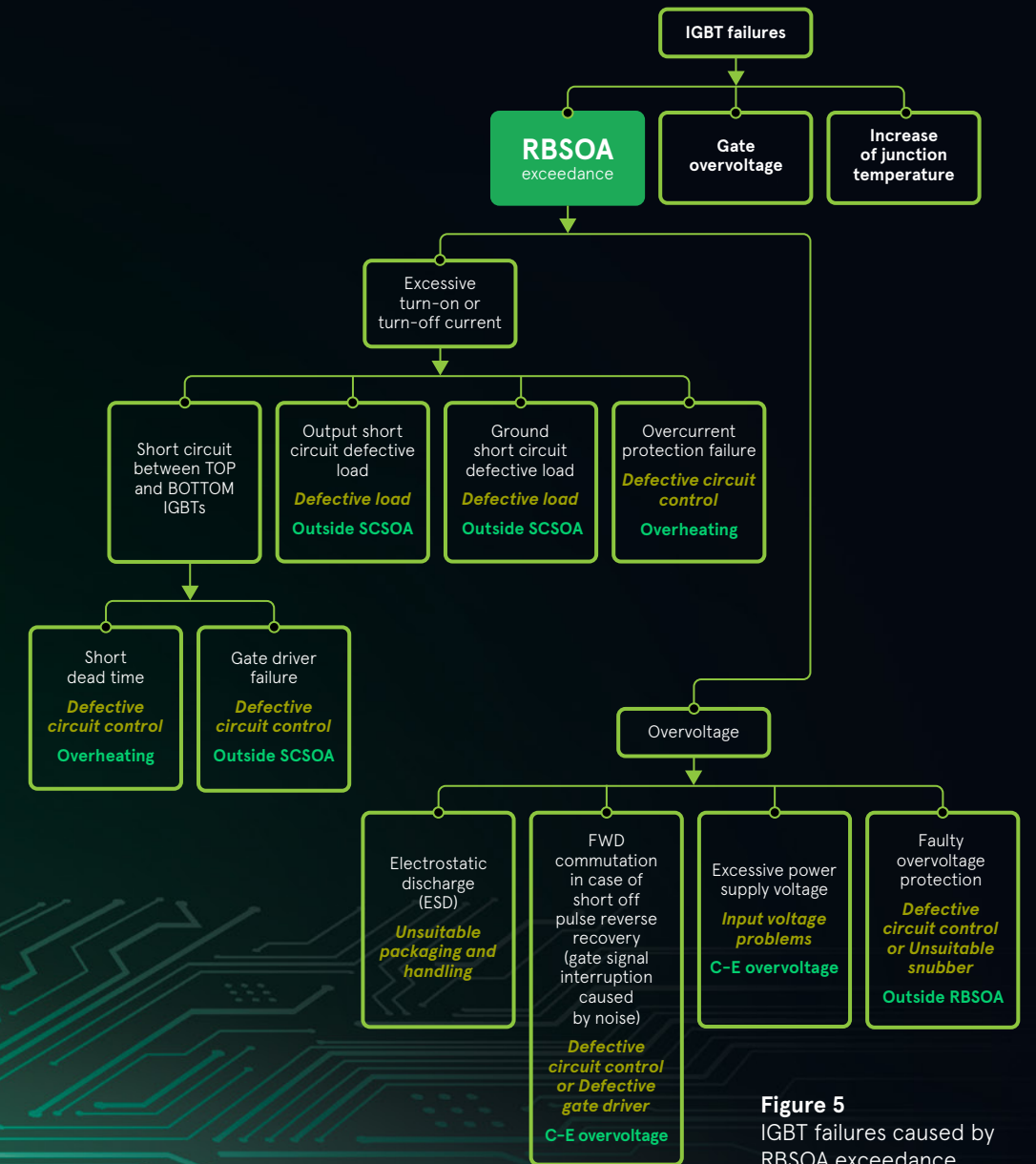
The main purpose here is for the manufacturer to adjust its processes to meet the customer's reliability expectations towards the end of the product life cycle and help to identify the time when this end is likely to occur.

It can happen that returned modules have failed right at the beginning of the application life cycle in the early stages of the bath-tub curve. Finding root-causes and potential fixes here is not easy and therefore, a systematic approach is recommended that should include the following considerations.

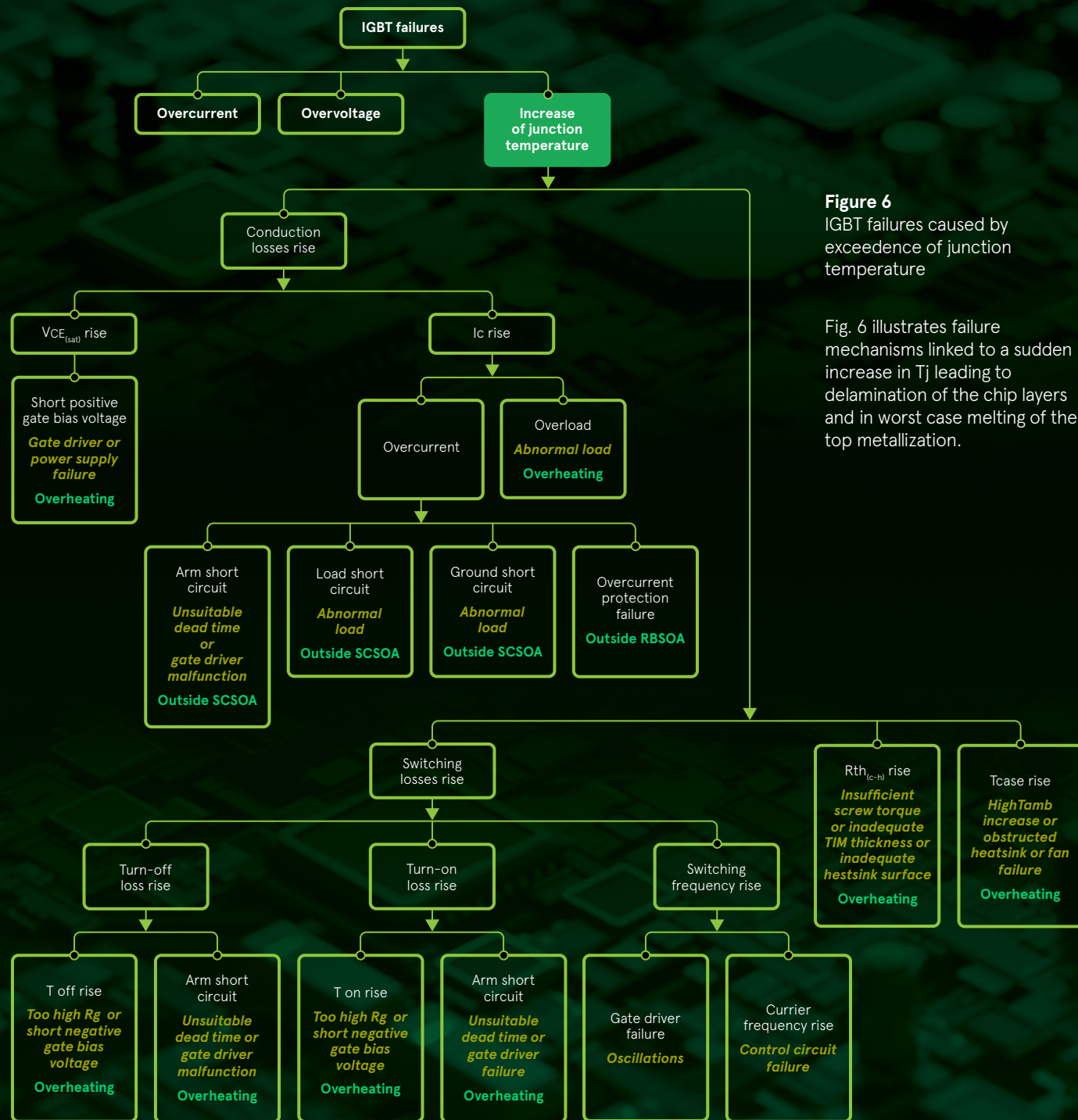
## STEP BY STEP APPROACH

From optical inspection, it is often straightforward to identify whether the IGBT and/ or the diode chip has failed. The following diagrams provide a non-exhaustive checklist of potential failure mechanisms that can be traced back mainly to the driver and protective circuit of the application and provide ideas of where to look for modifications on the respective PCB.

Looking at the IGBT, the first area to consider is the Reverse Bias Safe Operation Area (RBSOA) illustrated in Fig. 5, which is usually described as a range of  $V_{ce}$  and  $I_c$  under which the module can be operated without concern. The corresponding graph is typically described in the module data sheet.



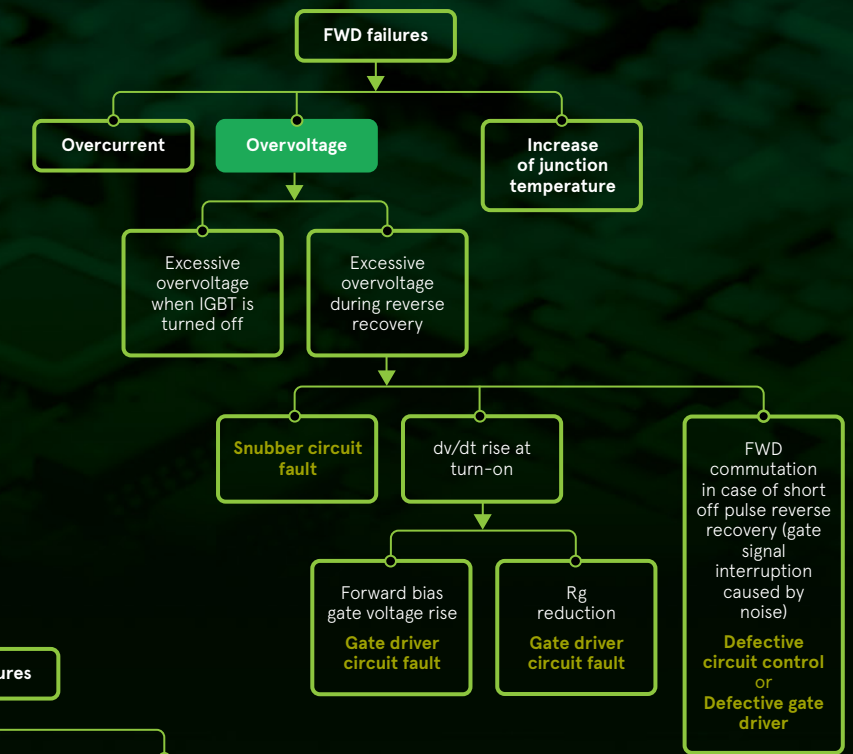
**Figure 5**  
IGBT failures caused by RBSOA exceedance



**Figure 6** IGBT failures caused by exceedence of junction temperature

Fig. 6 illustrates failure mechanisms linked to a sudden increase in Tj leading to delamination of the chip layers and in worst case melting of the top metallization.

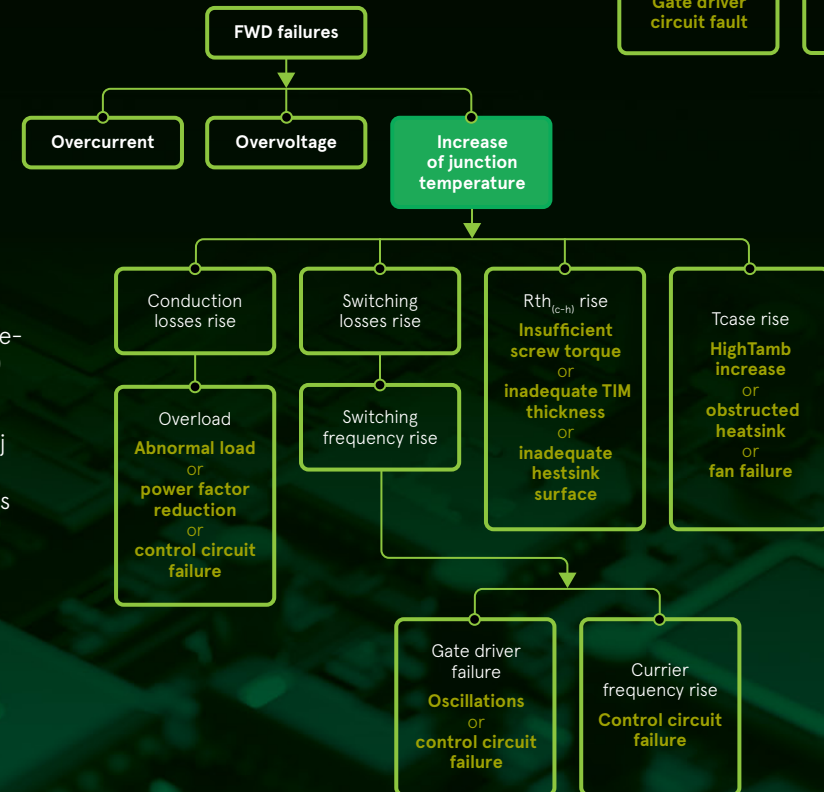
**Figure 7** Failures caused by overvoltage at the free-wheeling diode (FWD)



The other main area to consider in the IGBT-module is the FWD diode chip, which is deployed as a standard together with every IGBT die. Fig. 7 highlights again overvoltage events as a main source of these events, caused often by defective or unsuitable gate driver or control circuitry.

**Figure 8** Failures caused by overvoltage at the free-wheeling diode (FWD)

Sudden increase in Tj on the FWD can be a final area to look at as highlighted in Fig. 8.



## SUMMARY

Optical inspection of failed IGBT modules often show the effects but rarely give indication of the deeper cause of failure. Standard analysis techniques performed by the manufacturer can verify potential errors within the production process and help to find preventive solutions quickly and effectively. However, due to modern process control and inspection within the automated production lines as well as qualification tests in the module design phase, the result of such analysis often shows that no root cause can be attributed to the manufacturer directly. This leaves customers with a complex and often frustrating search within the application for which we want to provide guidance as well as assistance by our experienced FAE team.

To learn more about Starpower IGBT modules for motor driver applications,

[CLICK HERE](#)

# WE POWER AUTOMATION

## IGBT MODULE TECHNOLOGY FOR MOTOR DRIVE APPLICATIONS

StarPower offers a wide range of industry standard C5 and C6 packages in PIM or Sixpack topology for industrial motor drives and factory automation. Available is a range of 650V, 1200V and 1700V types in order to support a wide spectrum of applications. StarPower's Gen1 Trench-IGBT chip technology offers low VCE(sat) ratings with a positive temperature coefficient and is optimised for low conduction losses at switching frequencies below 15 kHz, which makes it the ideal work horse for industrial automation. The overall performance is enhanced by the fast and soft recovery free-wheeling diode (FWD) technology used. Thermally, the module range is equipped with established direct bond copper (DBC) substrates and copper baseplate for enhanced thermal spread and improved heat dissipation within switching operation.

"Our largest asset is the easy adaptability of our Gen1 Trench technology" explains Marcus Lippert, Business Development Manager for StarPower in Europe.

"The chip characteristics offer customers a solution that is widely compatible with what they are already using, often requiring only minor adaptations on the gate driver or control circuitry. This offers customers a low-key entry to implementing our technology as an alternative, especially in times of supply shortages."

For the segment of low power drives and servo amplifiers, StarPower is offering its Gen1 IGBT technology in commonly used, non-isolated TO-220 and TO-247 packages in a single switch configuration.

C5



C6

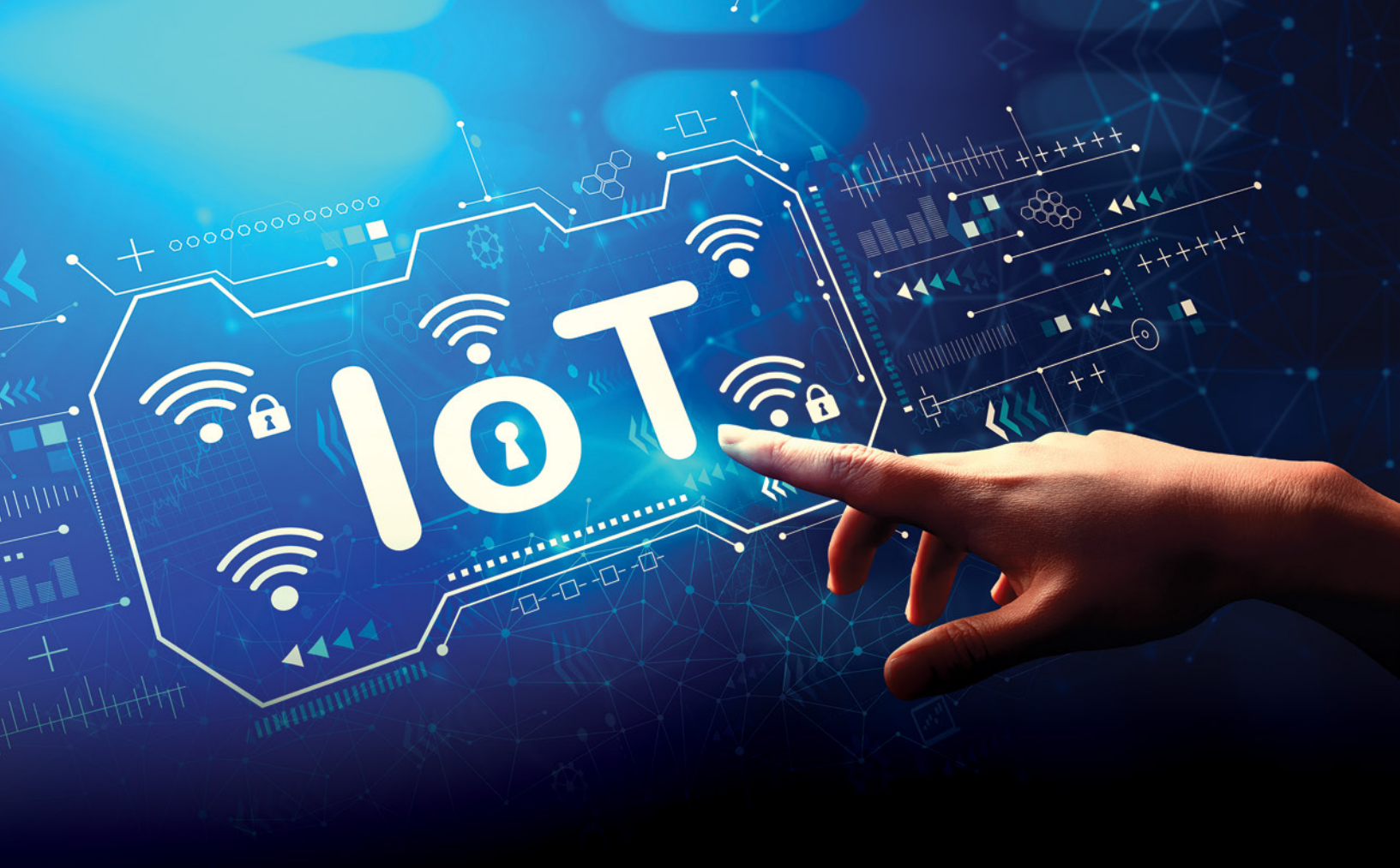


T1



T2





# WHERE IS IOT HEADING?

**DISCOVER WHAT IOT SOLUTIONS ENGINEERS AROUND THE WORLD SAID IN OUR LATEST SURVEY!**

We surveyed our engineer customers on IoT and received 2263 responses. This is the largest and most representative sample of engineers in the survey's four years!

[READ NOW](#)